

48336 / 01

www.baldwinhardware.com • Customer Service 1.800.437.7448

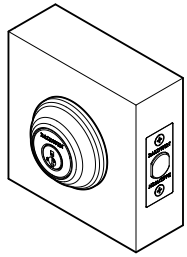

Tools Needed • Herramientas necesarias • Outils nécessaires



Electric Drill
 Taladro eléctrico
 Perceuse électrique

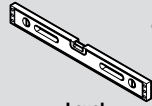

Level
 Nivel
 Niveau

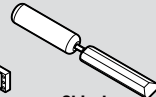

Chisel
 Cincel
 Ciseau



Hole Saw
 Sierra cilíndrica
 Scie cylindrique

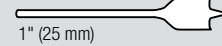

1" (25 mm)

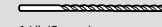

1/8" (3 mm)

Drill Bits
 Brocas
 Mèches



Ruler
 Regla
 Règle



Pencil
 Lápiz
 Crayon

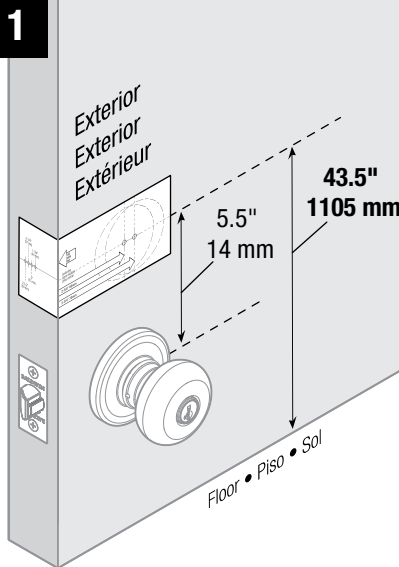

Select the template that allows you to place the template on the **EXTERIOR** side of door. Fold template along fold line and place fold line along the edge of door with the centerline approximately 43.5" (1105 mm) from floor.

Seleccione la plantilla que le permita colocarla del lado **EXTERIOR** de la puerta. Doble la plantilla a lo largo del doblez y coloque el doblez a lo largo del borde de la puerta con la línea central a unas 43.5" (1105 mm) del suelo.

Choisir le gabarit pouvant être placé sur le côté extérieur de la porte. Plier le gabarit le long de la ligne de pliage et placer la ligne de pliage le long du bord de la porte, avec l'axe à environ 43.5" (1105 mm) du sol.

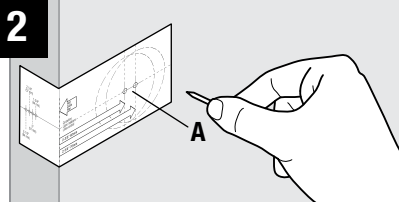

Mark hole A. Select desired backset before marking hole.

Marque el orificio A. Seleccione la distancia al centro deseada antes de marcar el orificio.

Marquez le trou A. Sélectionnez écartement désirée avant de marquer le trou.

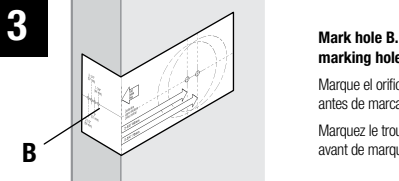

Mark hole B. Select door thickness before marking hole.

Marque el orificio B. Seleccione grosor de la puerta antes de marcar el orificio.

Marquez le trou B. Sélectionnez épaisseur de la porte avant de marquer le trou.

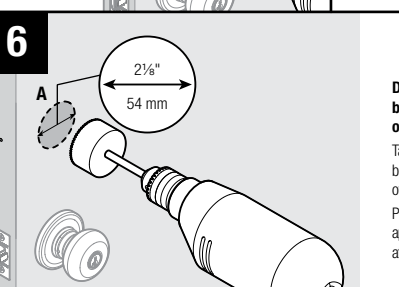
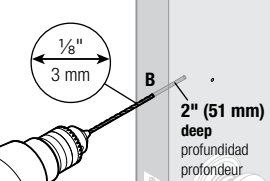
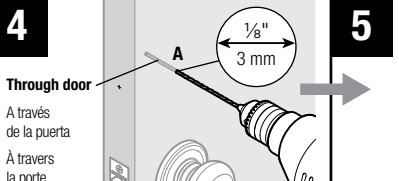

Drill from one side until the point of drill just breaks through, then complete hole from the other side to prevent splintering.

Taladre de un lado hasta que la punta de la brocasalga al otro lado, luego complete el orificio del otro lado para prevenir astillado.

Perçer à partir d'un côté jusqu'à ce que les dents de la scie apparaissent de l'autre côté, puis finir à partir de l'autre côté afin d'éviter de produire les éclats de bois.

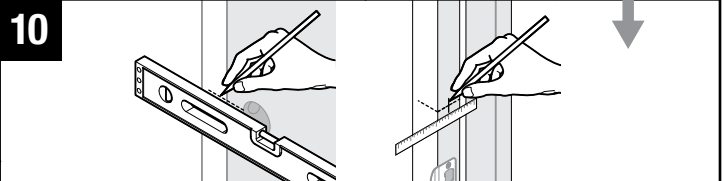
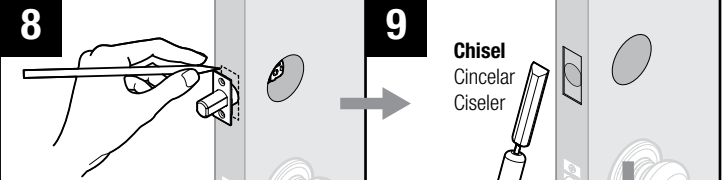
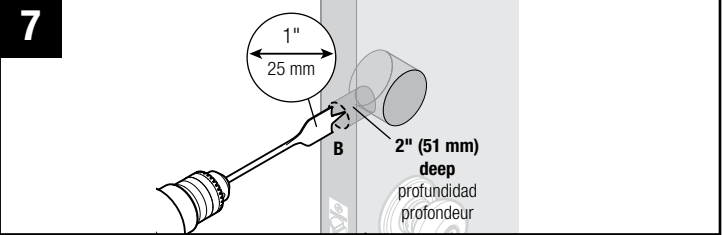

Mark straight line from center of bore holes across door jamb. Locate center of strike hole by measuring back from door stop, 1/2 the thickness of door.

Trace una línea recta desde el centro del orificio a través de la jamba de la puerta. Marque el centro del orificio de la placa midiendo hacia atrás desde el tope de la puerta, la mitad del espesor de la puerta.

Tracer une ligne droite du centre du trou de passage en travers du montant de porte. Trouver le centre du trou de la gâche en mesurant à partir de l'arrêt de porte à la moitié de l'épaisseur de la porte.

