

Pocket Door Mortise Locks - Classic

- Keyed - (2103)
- Passage - (2104)
- Privacy - (2105)
- Dummy - (2106)

- Fits standard door thickness 1 3/8" to 1 3/4"
- (Must Specify Door Thickness)
- Plates are 1/16" Thick

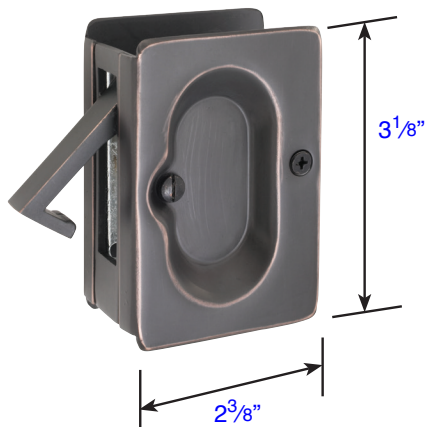

Passage Function (2101)

- Fits door thickness 1 3/8" to 1 3/4"
- Standard rectangular door prep 2 5/8" x 1 3/4"

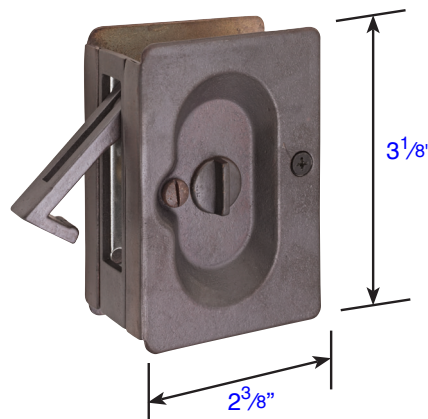

Privacy Function (2102)

- Fits door thickness 1 3/8" to 1 3/4"
- Standard rectangular door prep 2 5/8" x 1 3/4"
- Complete with strikeplate

Strike Plate
(for privacy only)

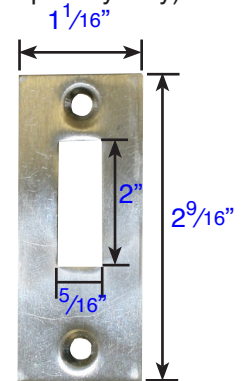

2" Screw-to-Screw
1/16" Thick

DIMENSIONS ARE IN INCHES

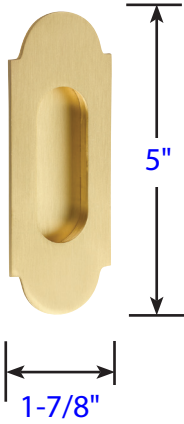

#8
Flush Pull
(2205)

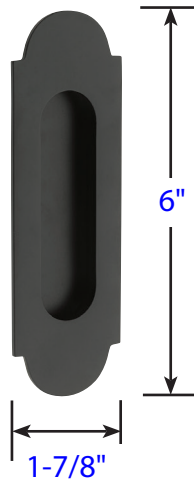

#8
Flush Pull
(2206)



Round
Flush Pull
(2211)

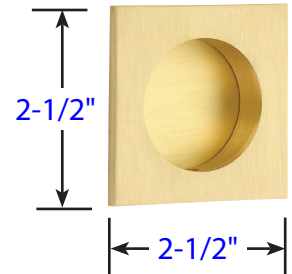

Square
Flush Pull
(2213)

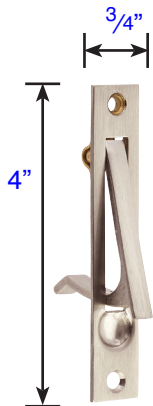

Edge Pull
with Screws
(2221)

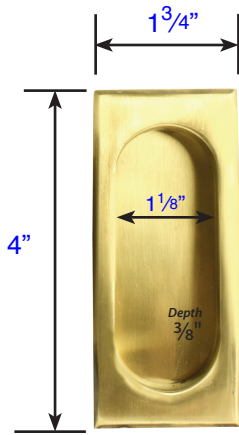

Rectangular
Flush Pull
(2201)

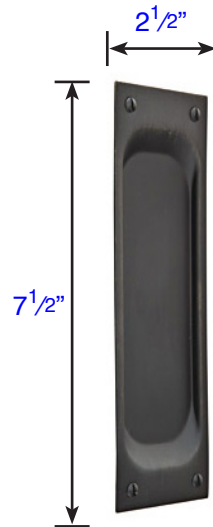

Classic
Rectangular
Flush Pull
(2216)

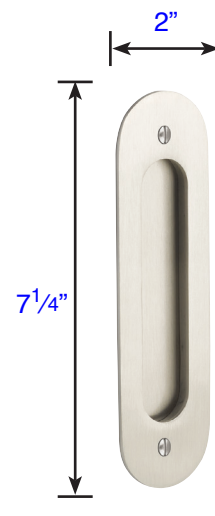

Narrow Oval
Flush Pull
(2212)

DIMENSIONS ARE IN INCHES

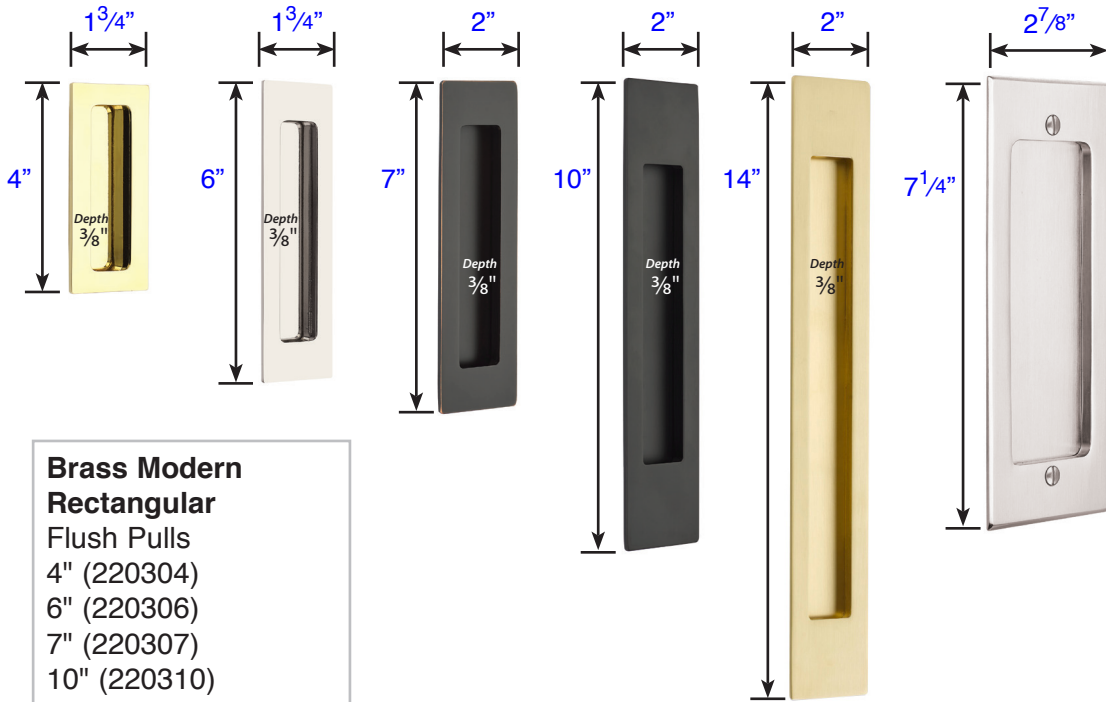

Brass Modern Rectangular Flush Pulls
4" (220304)
6" (220306)
7" (220307)
10" (220310)
14" (220314)

Brass Modern Rectangular Flush Pulls
2 7/8" x 7 1/4" (2215)

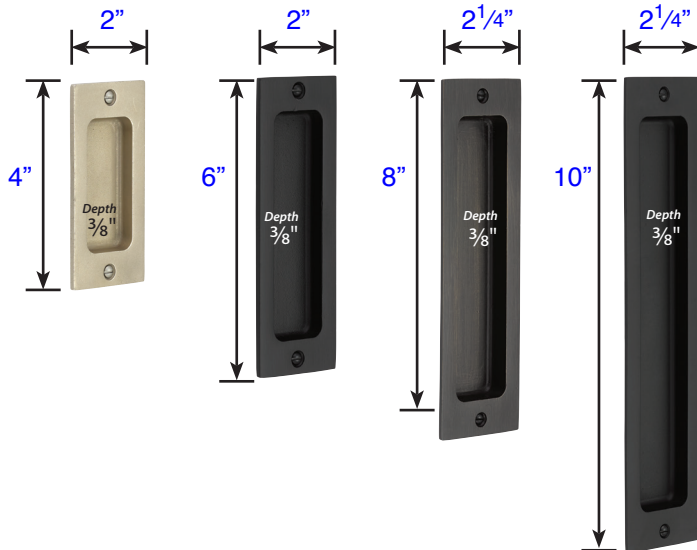

Sandcast Bronze Rustic Modern Rectangular Flush Pulls
4" (220404)
6" (220406)
8" (220408)
10" (220410)

DIMENSIONS ARE IN INCHES

Cabinet Latch

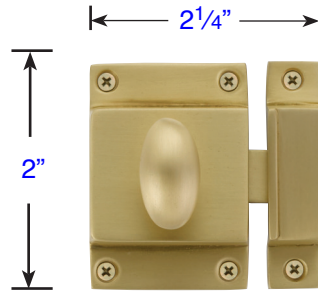

Cabinet Latch (2270)

Solid Brass Casement Latches

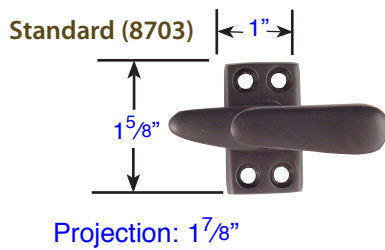

Projection: 1 7/8"

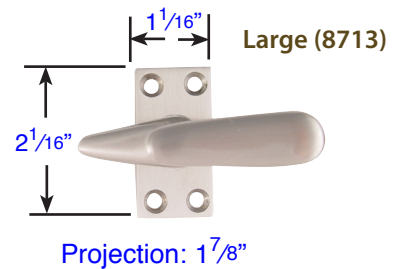

Projection: 1 7/8"

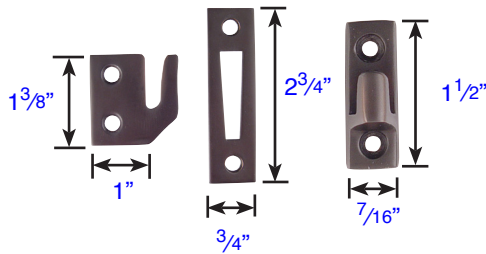

Door Catch

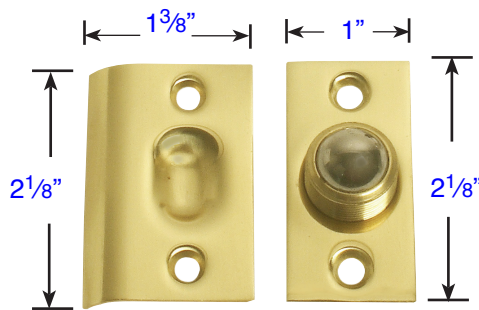

Ball Catch
 with Strike & Screws (8802)

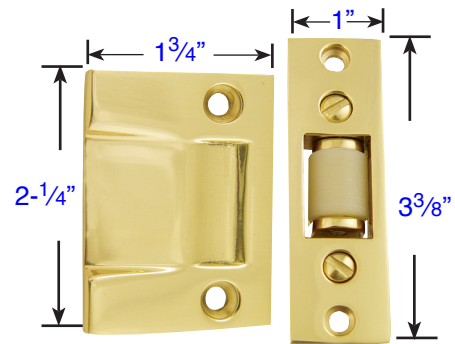

Roller Catch
 with Strike & Screws (8801)

DIMENSIONS ARE IN INCHES



Window Utility Pulls

Description	Product Code
4" Window, Utility Pulls	2244
6" Window, Utility Pulls	2246

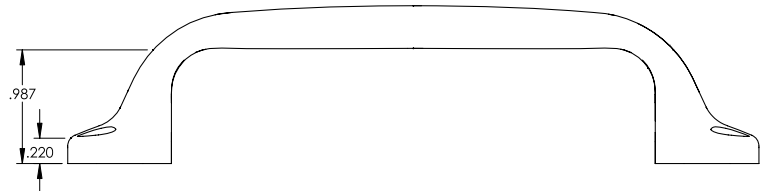
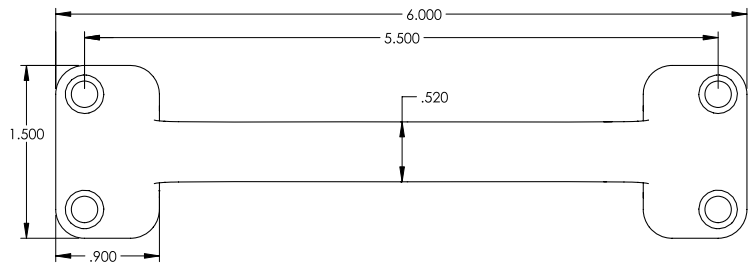
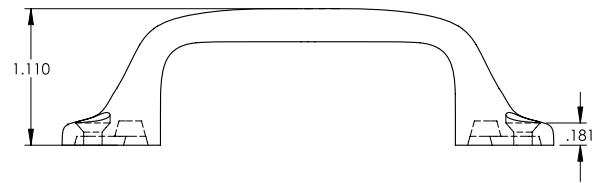
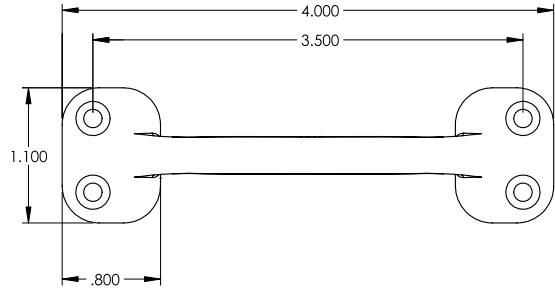

DIMENSIONS ARE IN INCHES

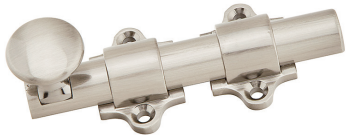

4" Dutch Door Bolts

Description	Product Code
4" Dutch Door Bolt	8516

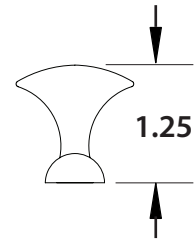
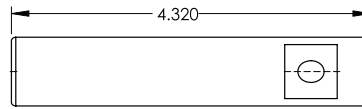

Mortise Strike

Lip Strike

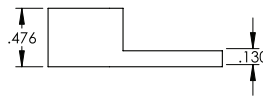
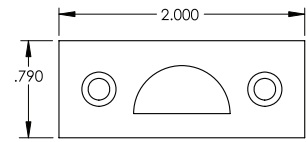
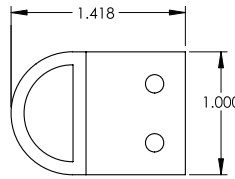

> Supplied with 2 Types of Strike Plates with Screws. Strikes & Screws are **NOT** sold separately.

Patio Door Bolts, Keyed

Description	Product Code
Silver	206011
Bronze	206012
White	206016
Black	206017

Patio Door Bolts, Non-Keyed

Description	Product Code
Silver	206511
Bronze	206512
White	206516

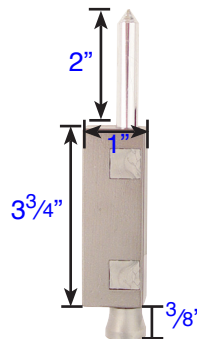

DIMENSIONS ARE IN INCHES

Solid Brass Surface Bolts

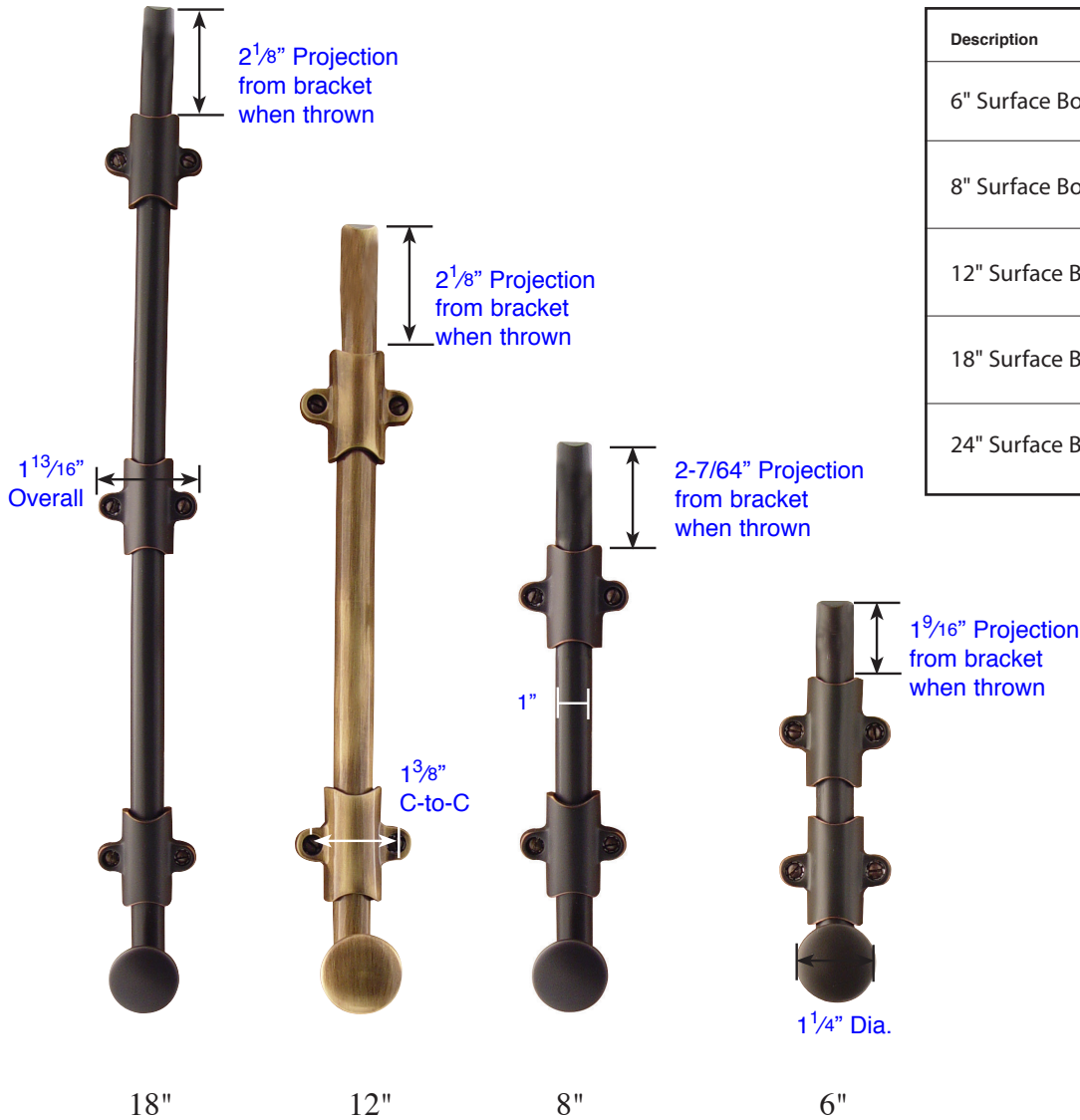

Description	Product Code
6" Surface Bolt	8511
8" Surface Bolt	8515
12" Surface Bolt	8512
18" Surface Bolt	8513
24" Surface Bolt	8514

Surface Bolts Strike Plates

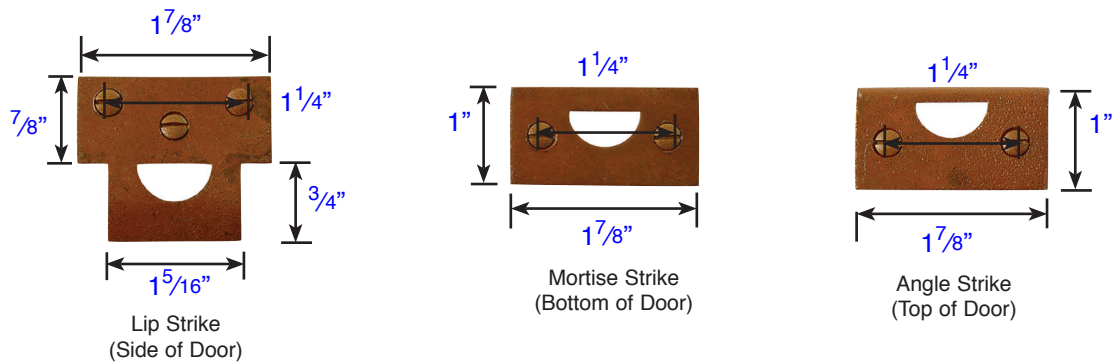

DIMENSIONS ARE IN INCHES

Concealed Screw Surface Bolts

Description	Product Code
4" Concealed Screw Surface Bolt	8527
6" Concealed Screw Surface Bolt	8528
8" Concealed Screw Surface Bolt	8529
12" Concealed Screw Surface Bolt	8530

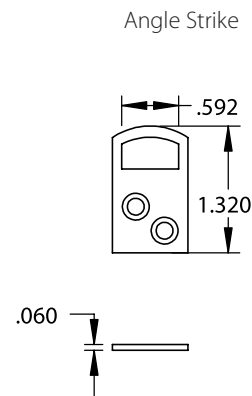
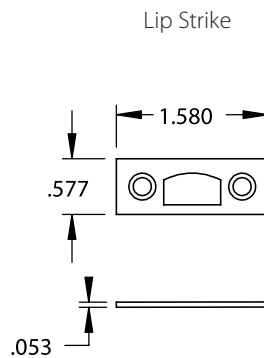
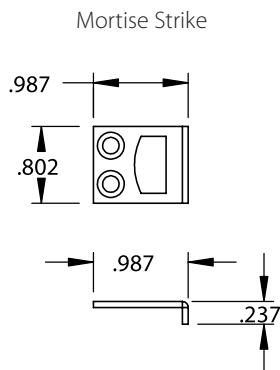
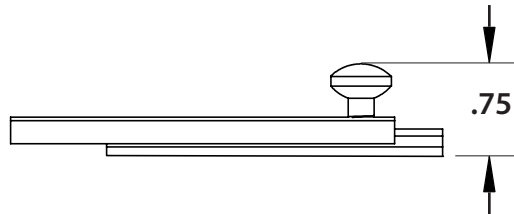
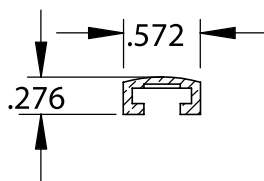

> Supplied with 3 Types of Strike Plates with Screws. Strikes & Screws are **NOT** sold separately.

DIMENSIONS ARE IN INCHES

12" Flush Bolts

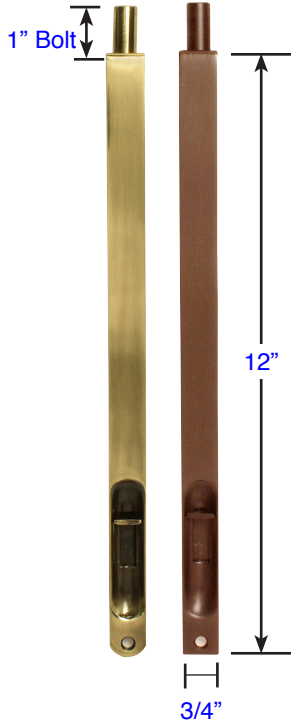

6" Flush Bolts

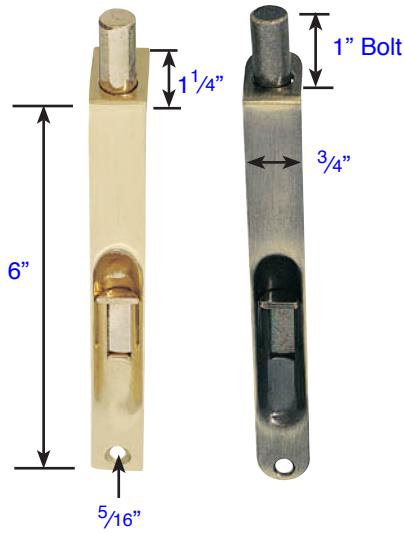

4" Flush Bolts

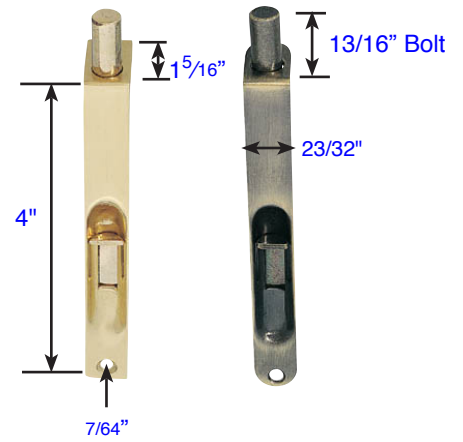

Flush Bolt Strike

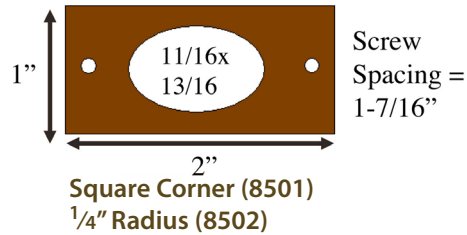

DIMENSIONS ARE IN INCHES

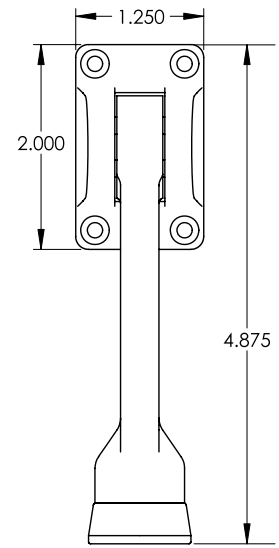
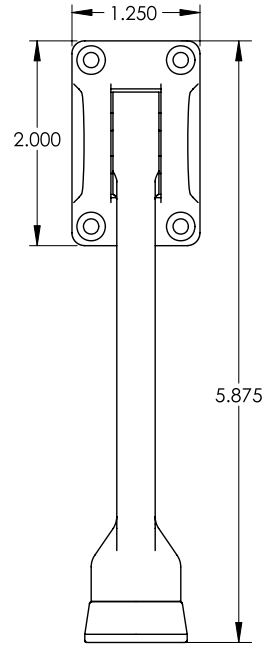

**Discontinued.
No Longer Available**

Kickdown Door Holders with Screws

Description	Product Code
5" Kickdown Door Holder	2264
5" Kickdown Door Holder	2265



3" Magnetic Door Stop & Holder

Product Code
2256

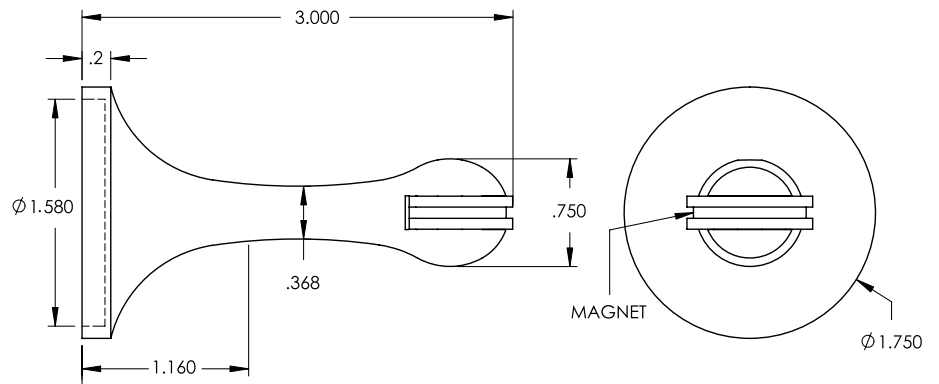

DIMENSIONS ARE IN INCHES

Door Stops *with Screws*

Description	Product Code
Half Dome	2251
Goose Style	2253

Half Dome
Door Stop
(2251)



1" Projection (tall)
1¹³/₁₆" Base Diameter

Goose Style
Door Stop
(2253)



2 1/2"
2 7/8" Tall

Door Stops

Description	Product Code
3"	2232
4"	2231



Base = 1 1/4"

Hinge Pivot Stop

Description	Product Code
Hinge Pivot Stop	2241
Extended Button Tip (Used on Solid Brass Hinges)	2242

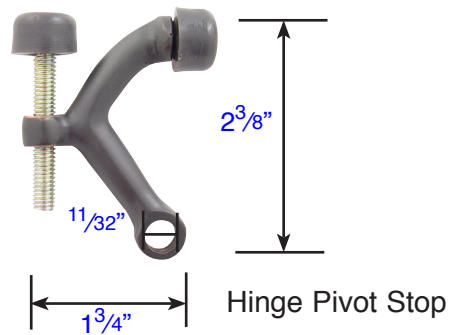

Hinge Pivot Stop

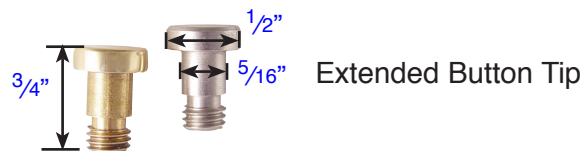

Extended Button Tip

DIMENSIONS ARE IN INCHES

Cylinder Floor Bumpers *with Screws*

Description	Product Code
1 1/2" Cylinder	2257
2" Cylinder	2258



Cylinder Floor Bumpers with Dome Cap *with Screws*

Description	Product Code
1 1/2" Cylinder	2259
2" Cylinder	2260



Extendable Baseboard Door Bumper

Product Code
2233

>> Includes 3", 1", and 1/2" base with 2" screw

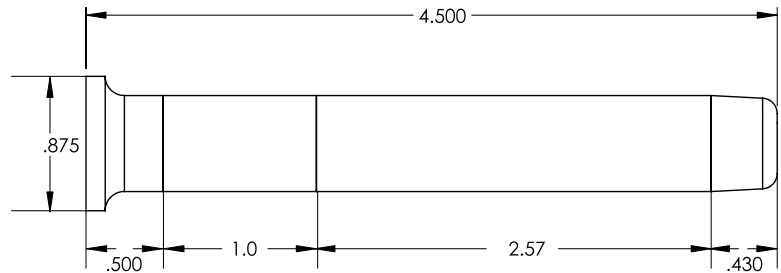

Floor Door Bumper

Product Code
2254

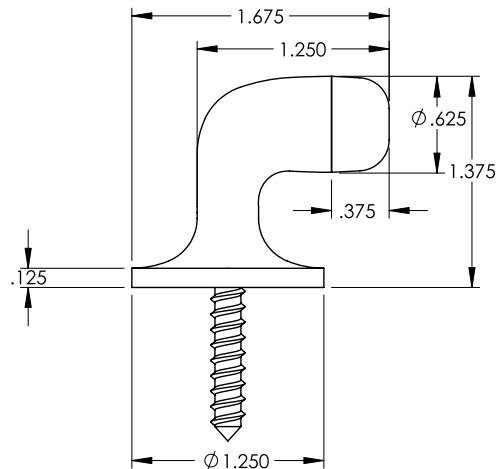

DIMENSIONS ARE IN INCHES

Brass Wall Bumper
with #8 Rosette
(2255)

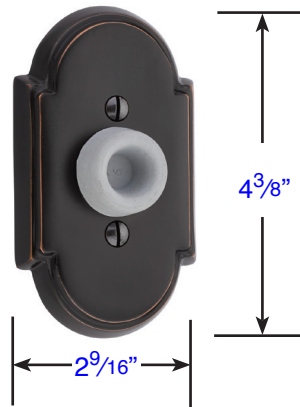

Brass Wall Bumper
with Square Rosette
(2255)

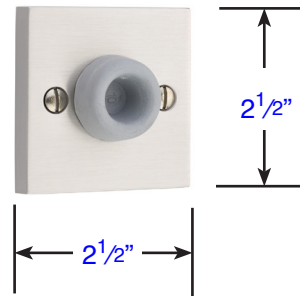

Brass Wall Bumper
with Regular Rosette
(2255)

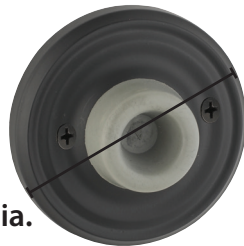

Sandcast Bronze Wall Bumper
with #2 Rosette
(2255)

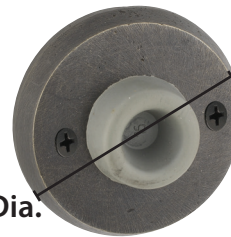

• Same dimensions for rosettes & doorbell buttons

DIMENSIONS ARE IN INCHES

Solid Brass Mail Slot

Solid Brass Mail Slot (2280)

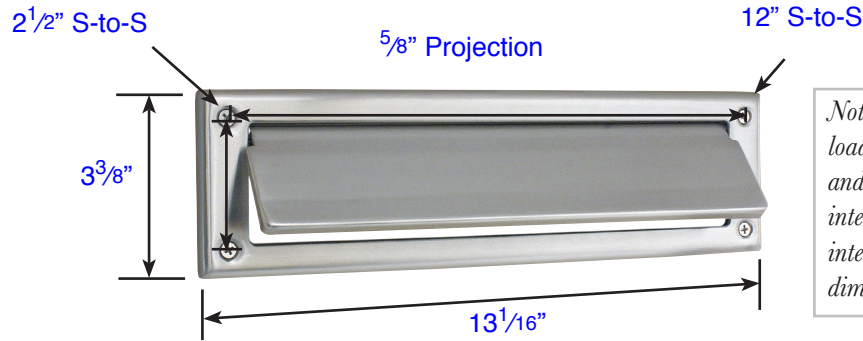

Note: Mail flap is spring loaded on the exterior and swing loosely on the interior. Both exterior and interior trims have the same dimensions.

Door Knockers

**Solid Brass Door Knocker
 Urn Style (2620)**

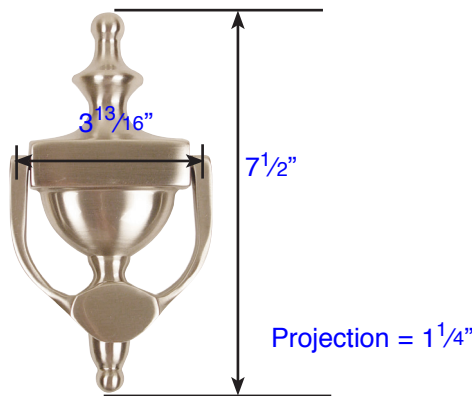

**Bronze Door Knocker
 with 4" Ring Pull (86060)**

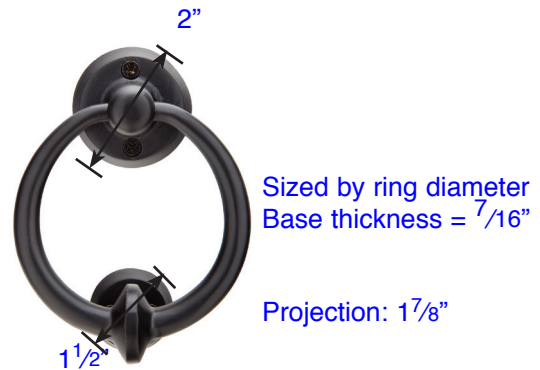

Note: We recommend that US3 finish be selected for those who intend to have the door knocker engraved. Emtek does not offer engraving services at this time

Solid Brass Door Viewer

**Solid Brass Door Viewer
 (2610)**



• Fits standard door thickness 1 3/8" to 2" (not available for thicker door)

DIMENSIONS ARE IN INCHES

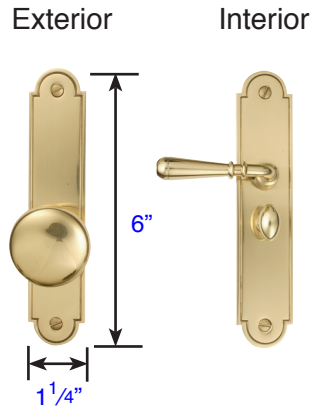

Arch Style
Brass (2290)
Bronze (2290)

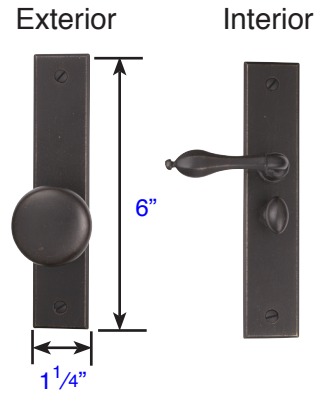

Rectangular Style
Brass (2291)
Bronze (2291)

Exterior & Interior
Clearance: 3/4"
Projection: 1 5/8"
Lever Length: 2 5/8"
Knob Diameter: 1 11/16"
Door Thickness Specifications: 1"-1 3/4"

DIMENSIONS ARE IN INCHES



Mounting Options

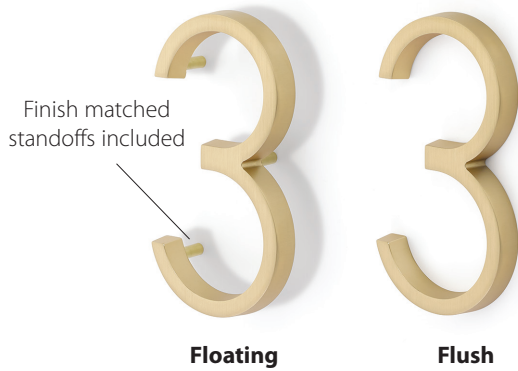

Hardware Included

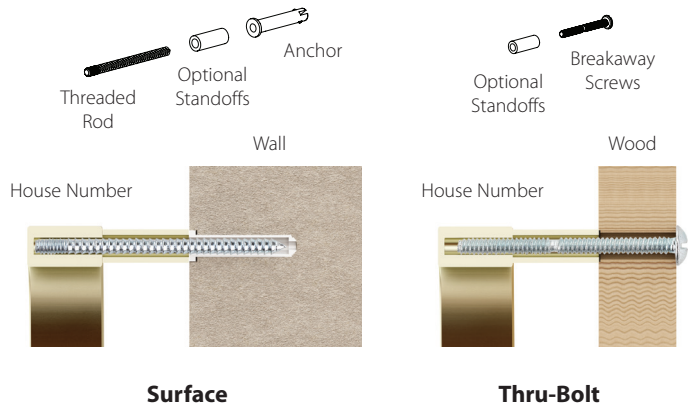

DIMENSIONS ARE IN INCHES



5 1/2" (2820)



5 1/2" (2821)



5 1/2" (2822)



5 1/2" (2823)



5 1/2" (2824)

**Discontinued.
No Longer Available**

**5 1/2"
BRASS**

Brass 5 1/2"
Width: 2 3/4"
Thickness: 3/16"

Supplied With Matching Screws



5 1/2" (2825)



5 1/2" (2826)



5 1/2" (2827)



5 1/2" (2828)



5 1/2" (2829)



6" (2820)



6" (2821)



6" (2822)



6" (2823)



6" (2824)

6" BRONZE

Bronze 6"
Width: 4 5/8"
Thickness: 3/16"



6" (2825)



6" (2826)



6" (2827)



6" (2828)



6" (2829)

DIMENSIONS ARE IN INCHES

**Discontinued.
No Longer Available**

Supplied With Matching Screws & Lighted Button

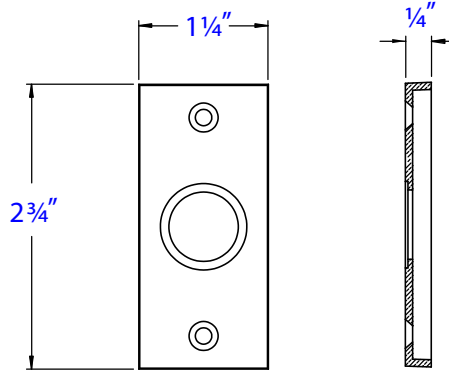

Screw to Screw: $2\frac{1}{10}$ "
Small Rectangular Style
(2464)

**Discontinued.
No Longer Available**

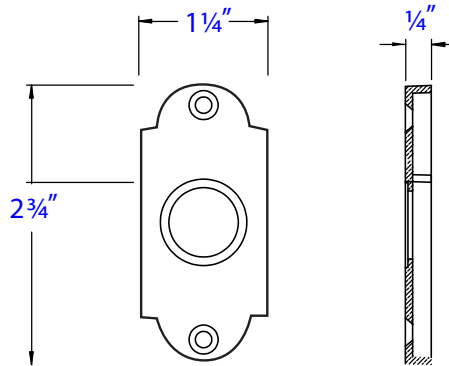

Screw to Screw: $2\frac{1}{4}$ "
Small #1 Style
(2461)

**Note:
These are the dimensions for these two styles only. All other doorbell button
rosettes are the same dimensions as the passage/privacy rosettes.*

DIMENSIONS ARE IN INCHES

Supplied With Matching Screws & Lighted Button

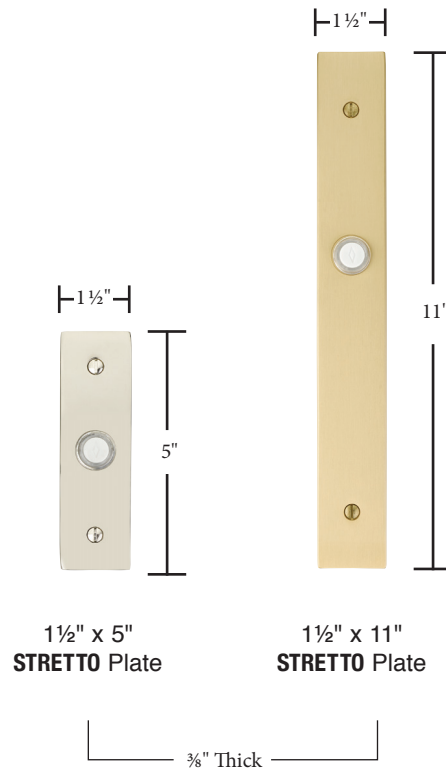

***Note:**

These are the dimensions for these two styles only. All other doorbell button rosettes are the same dimensions as the passage/privacy rosettes.

DIMENSIONS ARE IN INCHES